



Foshan Sunde Metal Manufacture Co.Ltd





SKIRTING TRUNKING SERIES

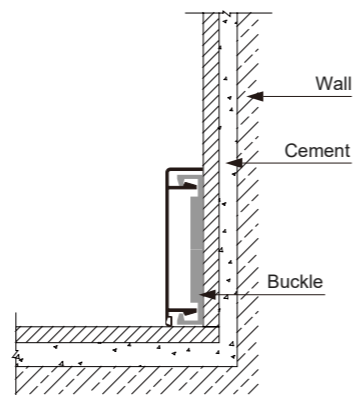

ALUMINUM SKIRTING BOARD

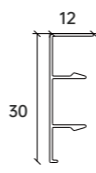
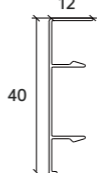
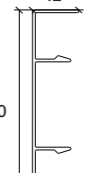
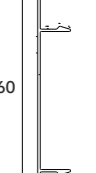
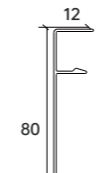
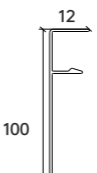

CAD LINE GRAPH

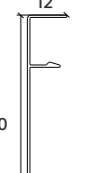
 <p>BM-XRY-100 LENGTH 2.5 THICKNESS (mm) 0.8</p>	 <p>BM-XRY-101 LENGTH 2.5 THICKNESS (mm) 0.8/1.0</p>	 <p>BM-XRY-102 LENGTH 2.5 THICKNESS (mm) 0.8/1.0</p>	 <p>BM-XRY-103 LENGTH 2.5 THICKNESS (mm) 0.8/1.0</p>
 <p>BM-XRY-104 LENGTH 2.5 THICKNESS (mm) 0.8/1.0/1.2</p>	 <p>BM-XRY-105 LENGTH 2.5 THICKNESS (mm) 0.8/1.0/1.2</p>	 <p>BM-XRY-106 LENGTH 2.5 THICKNESS (mm) 0.8/1.0</p>	 <p>BM-XRY-107 LENGTH 2.5 THICKNESS (mm) 1.2</p>

ACCESSORIES

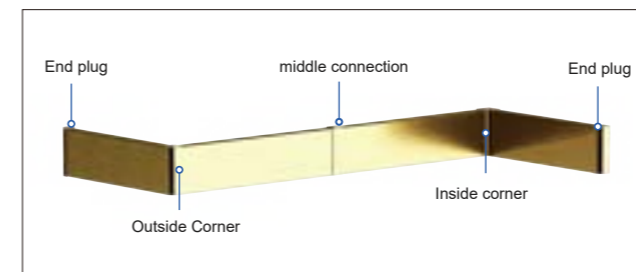
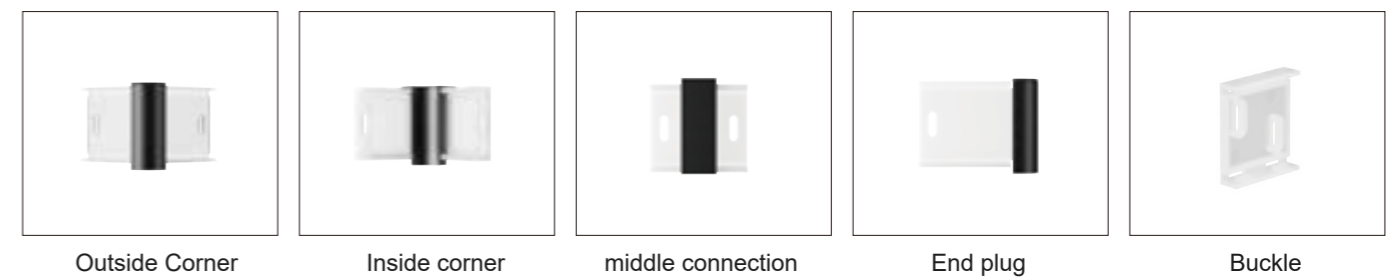

Front installation effect

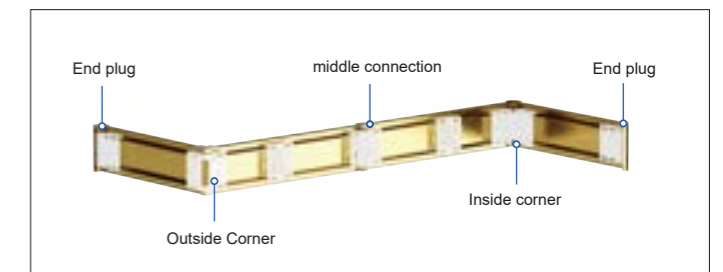

Installation effect on the back



HIDDEN SKIRTING LINE



CAD LINE GRAPH

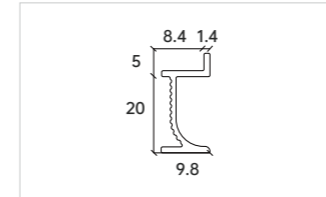

BM-XRY-108

LENGTH	THICKNESS (mm)
2.5	1.0

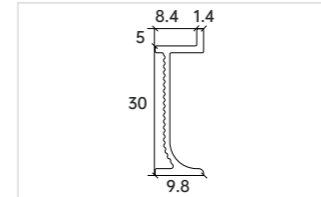

BM-XRY-109

LENGTH	THICKNESS (mm)
2.5	1.0

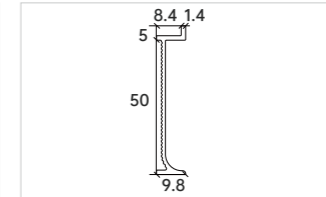

BM-XRY-110

LENGTH	THICKNESS (mm)
2.5	1.0

**ALUMINUM
EDGE
PROFILE**

ACCESSORIES



Outside Corner



Inside corner



middle connection



End plug



End plug

INSTALLATION RENDERINGS



LED LIGHT SWITH SKIRTING



CAD LINE GRAPH

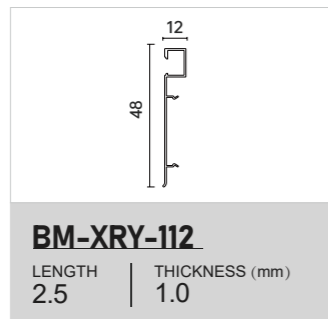
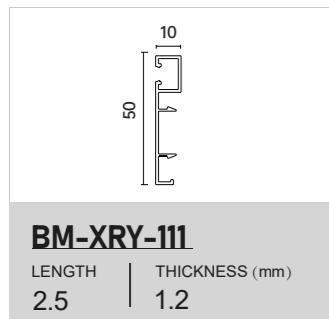

COLOR



ACCESSORIES

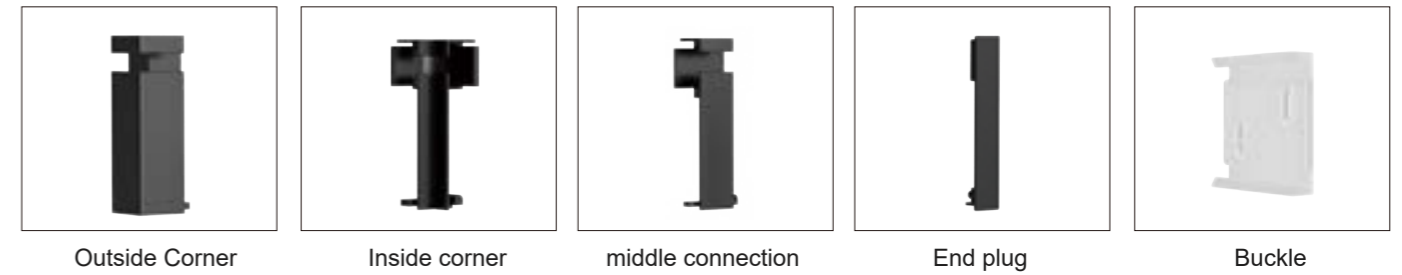

INSTALLATION STEPS



1.The reserved thread head is at the installation lamp slot, and the base is fixed.



2.Kick the line.



3.Stick the lamp strip into the lamp slot, and connect the positive and negative poles of the lamp strip with the thread end.



4.Connect the power supply for conducting test.



5.Button lampshade.



6.After the test, the light bar lights up normally.

HIDDEN SKIRTING LINE



COLOR

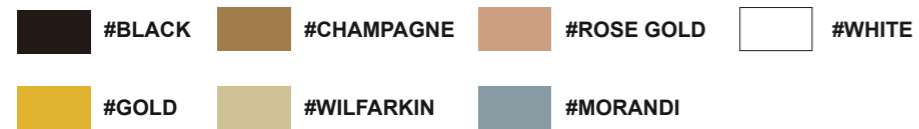

ACCESSORIES



End plug

End plug

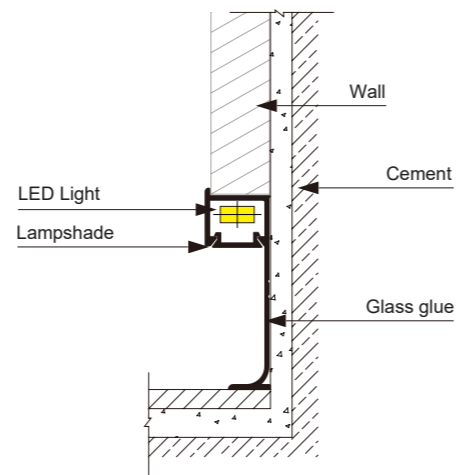

CAD LINE GRAPH

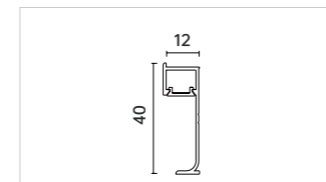

BM-XRY-113

LENGTH 2.5 | THICKNESS (mm) 0.8/1.0/1.2

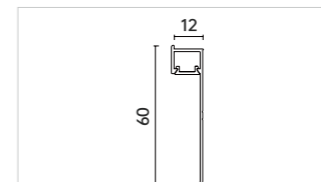

BM-XRY-114

LENGTH 2.5 | THICKNESS (mm) 0.8/1.0/1.2

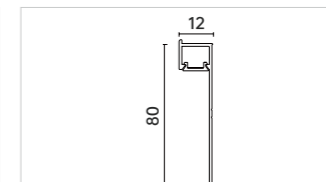

BM-XRY-115

LENGTH 2.5 | THICKNESS (mm) 0.8/1.0/1.2

**ALUMINUM
EDGE
PROFILE**





BASEBOARDS WITH LAMPSHADE



COLOR



ACCESSORIES



Outside Corner

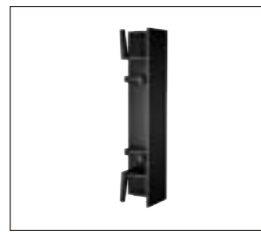

Inside corner



middle connection



End plug



Buckle

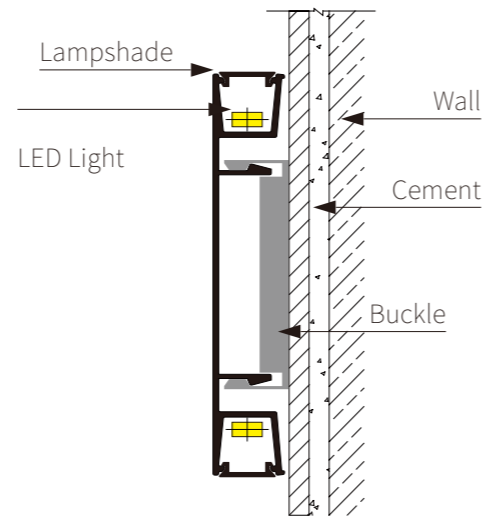

INSTALLATION RENDERINGS

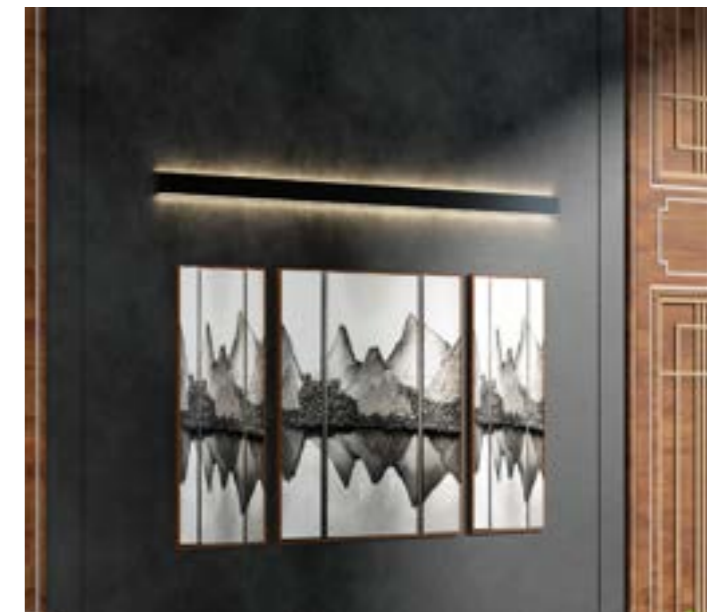

1.ALUMINUM SKIRTING LINE



CAD LINE GRAPH

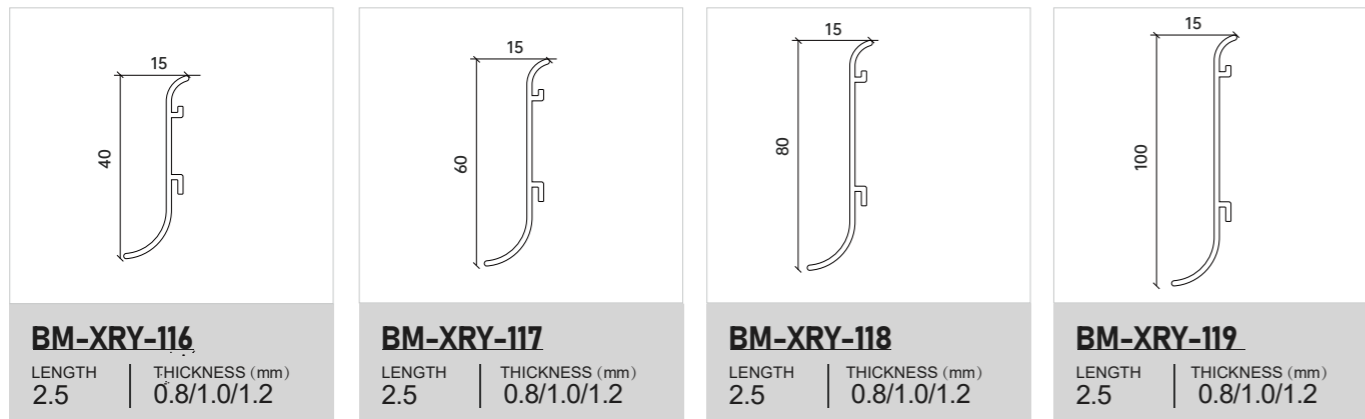

COLOR



ACCESSORIES



INSTALLATION RENDERINGS





2.ALUMINUM SKIRTING LINE



COLOR



ACCESSORIES

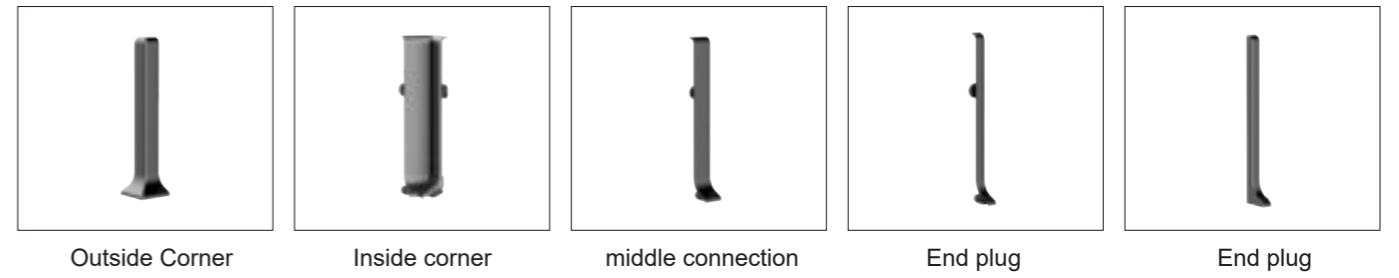

INSTALLATION RENDERINGS



CAD LINE GRAPH

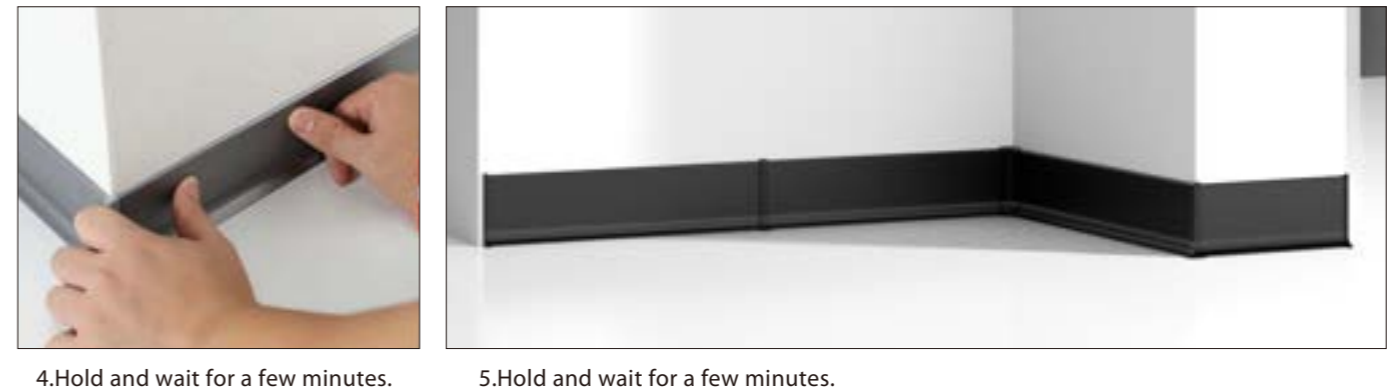
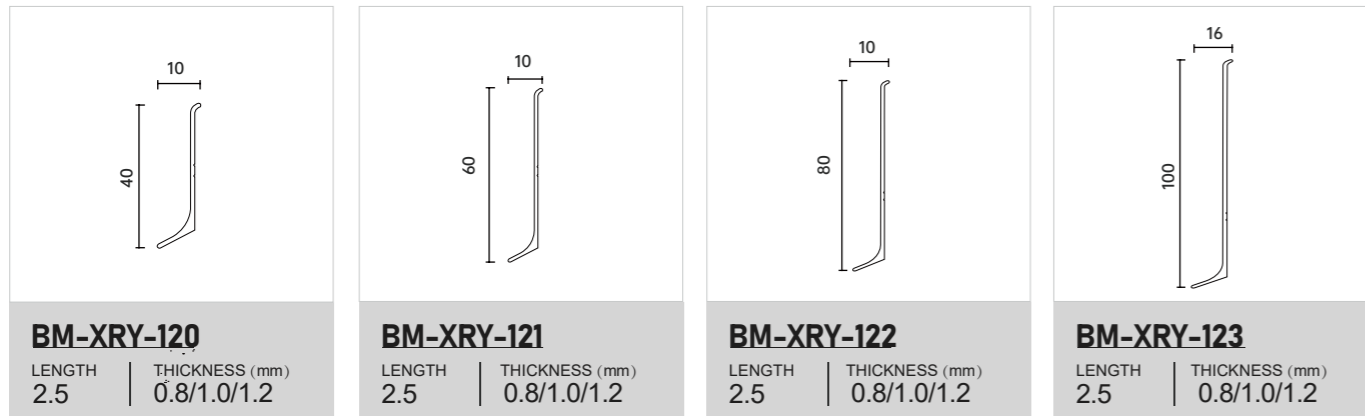

BASE-FREE STAINLESS STEEL SKIRTING



COLOR

- #BRUSHED ROSE GOLD
- #BRUSHED BLACK
- #BRUSHED STAINLESS STEEL SILVER
- #BRUSHED TITANIUM GOLD

ACCESSORIES



Outside Corner

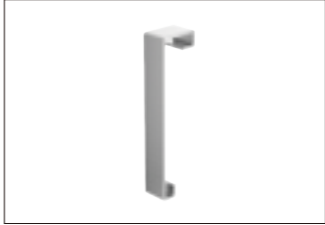

Inside corner

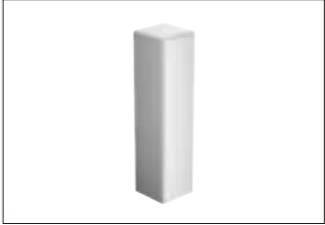

End plug



Buckle

CAD LINE GRAPH

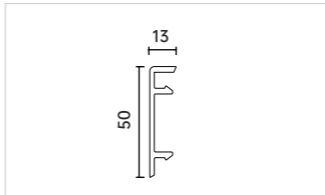

BM-XRY-124
LENGTH 2.5 | THICKNESS (mm) 3.0

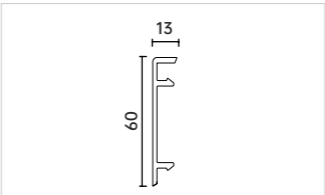

BM-XRY-125
LENGTH 2.5 | THICKNESS (mm) 3.0

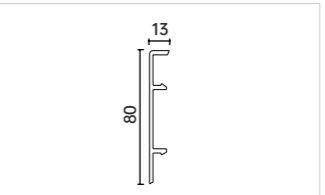

BM-XRY-126
LENGTH 2.5 | THICKNESS (mm) 3.0

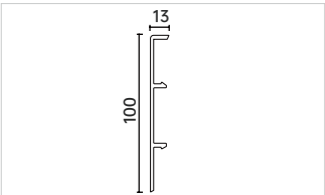

BM-XRY-127
LENGTH 2.5 | THICKNESS (mm) 3.0



1. STAINLESS STEEL SKIRTING



COLOR



CAD LINE GRAPH

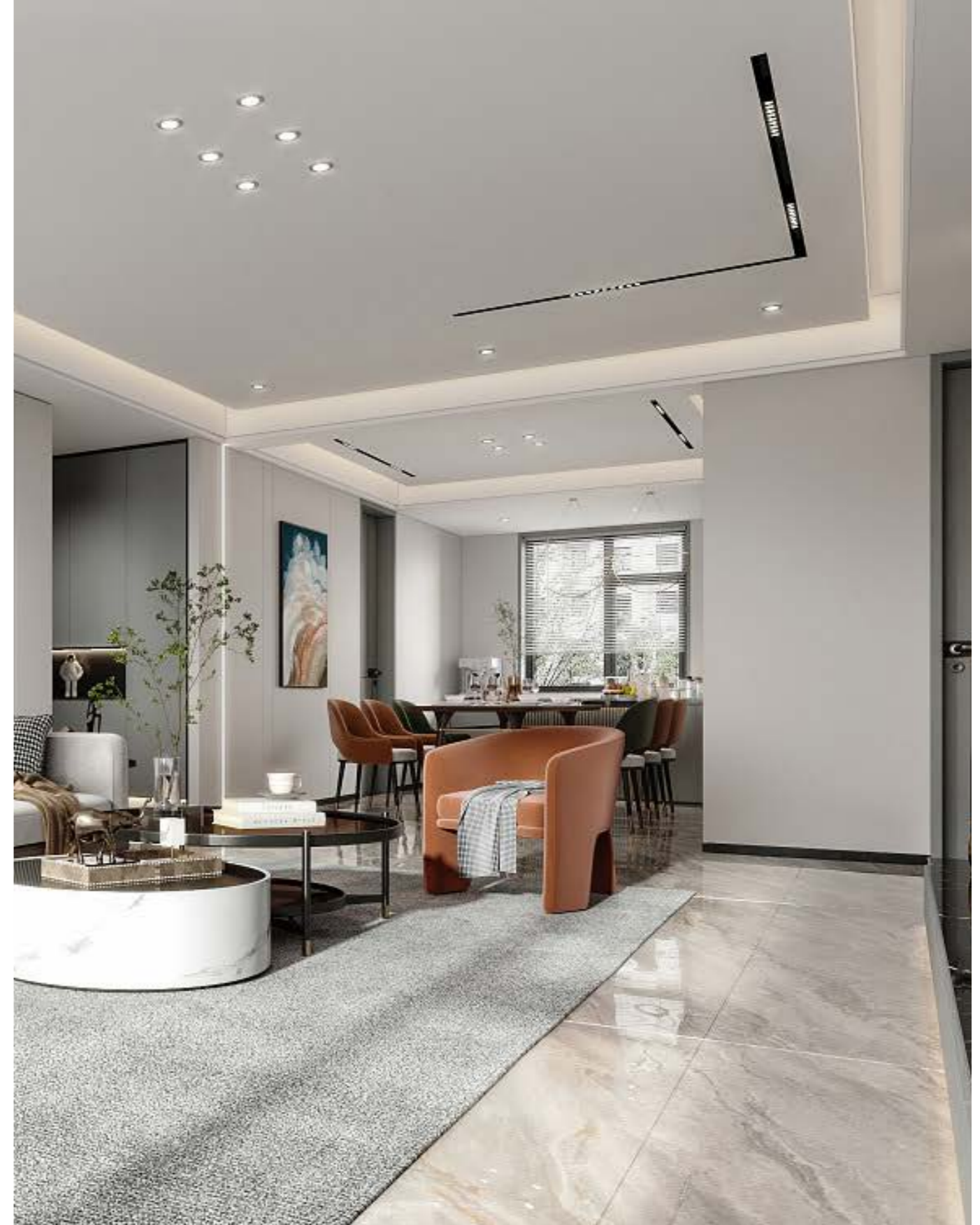
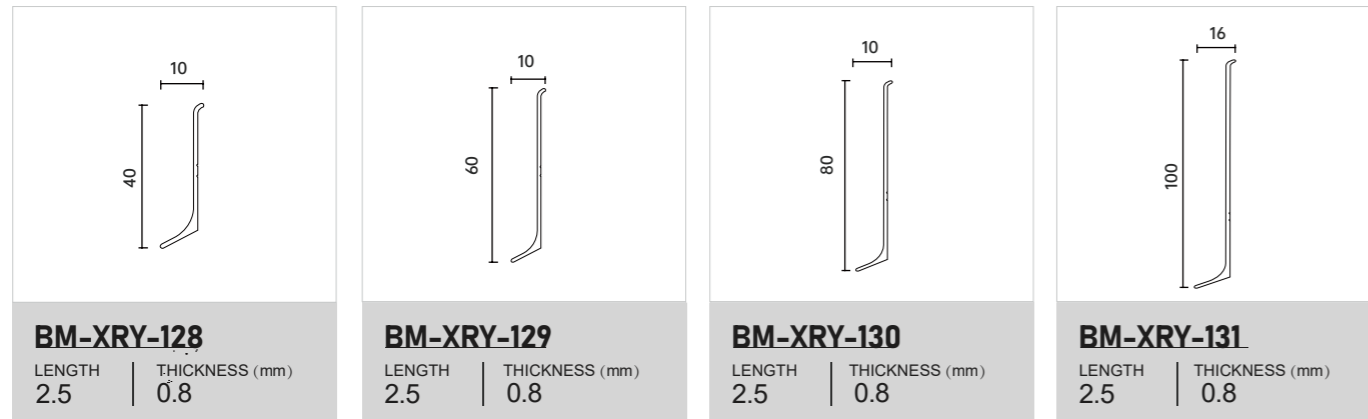



2.STAINLESS STEEL SKIRTING



COLOR

- #BRUSHED ROSE GOLD
- #BRUSHED BLACK
- #BRUSHED STAINLESS STEEL SILVER
- #BRUSHED TITANIUM GOLD

CAD LINE GRAPH

